

Article number: 0101222  
 Description: Retaining ring A 440 DIN 471  
 Spring steel  
 Note: Fitted with ZGA pilers

## Measures

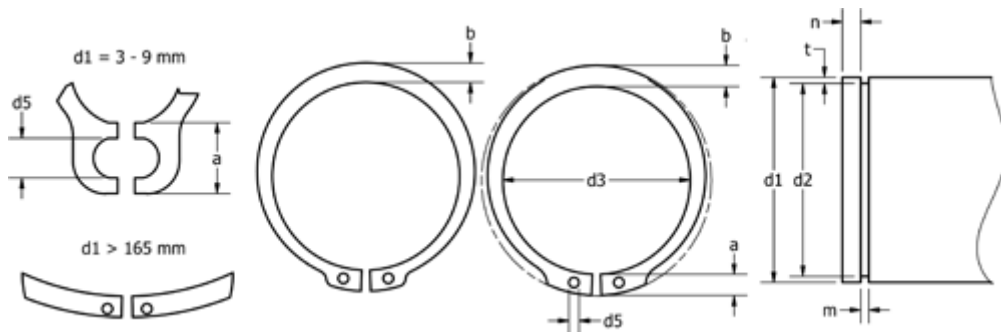

a max	=	FN kN	= 1363.0	s	= 7.00
AN mm <sup>2</sup>	= 8181.0	FRg kN	= 129.00	t	= 6.00
b	= 26.0	FR kN	= 1500.00	tol	= -1.00
d1	= 440	g	= 7.0	tol	= -0.15
d2	= 428.0	K kN-mm	= 3448.00	tol	= +1,00-2,00
d3	= 420.0	m min	= 7.20	Tong	= ZGA-7
d5 min	= 6.0	n abl x 1000	= 1.0	Weight kg/1000	= 999.999
Description	= A440	Nominal drive	= 18.0		